

FIG. 1

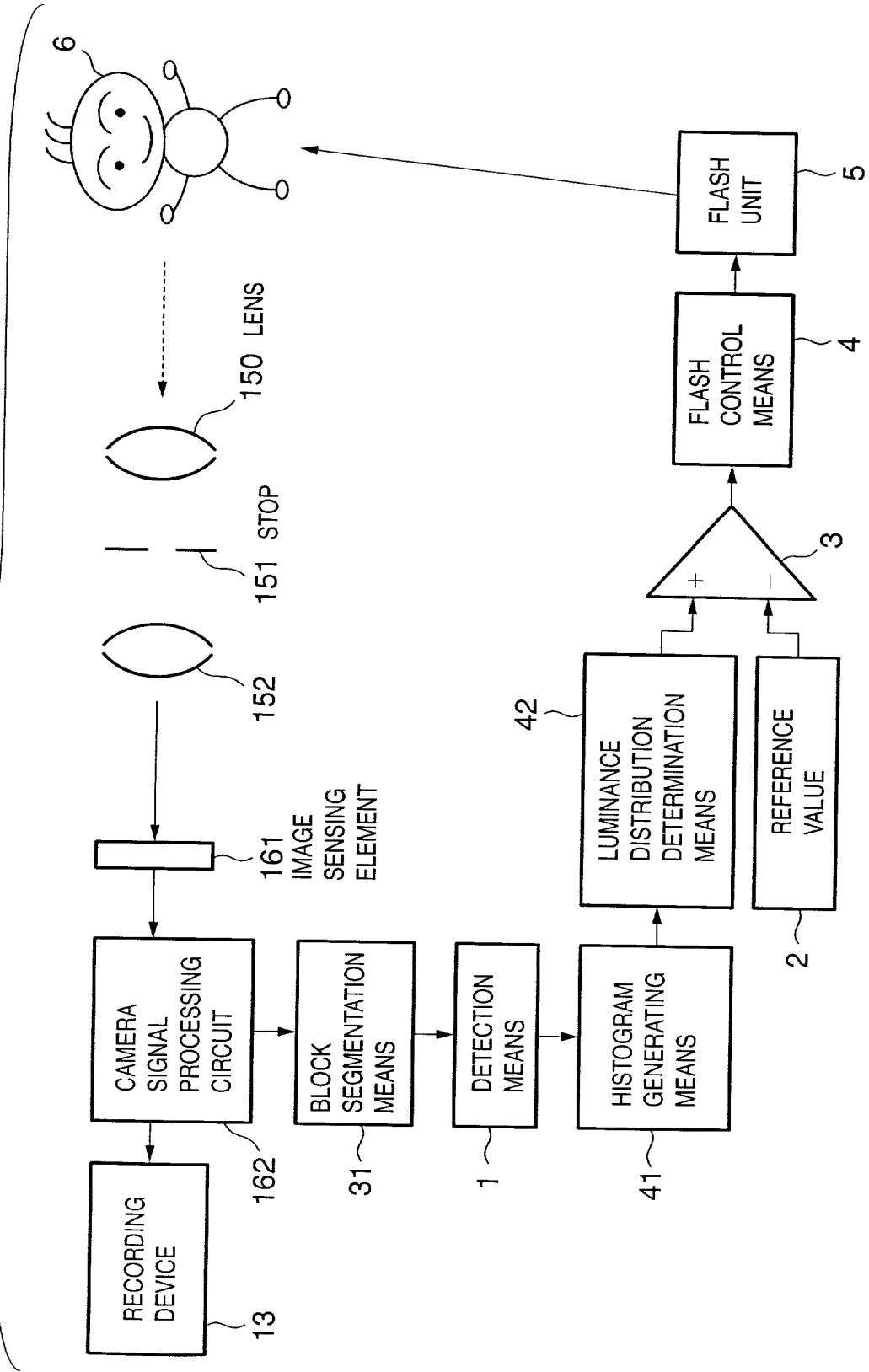

FIG. 2

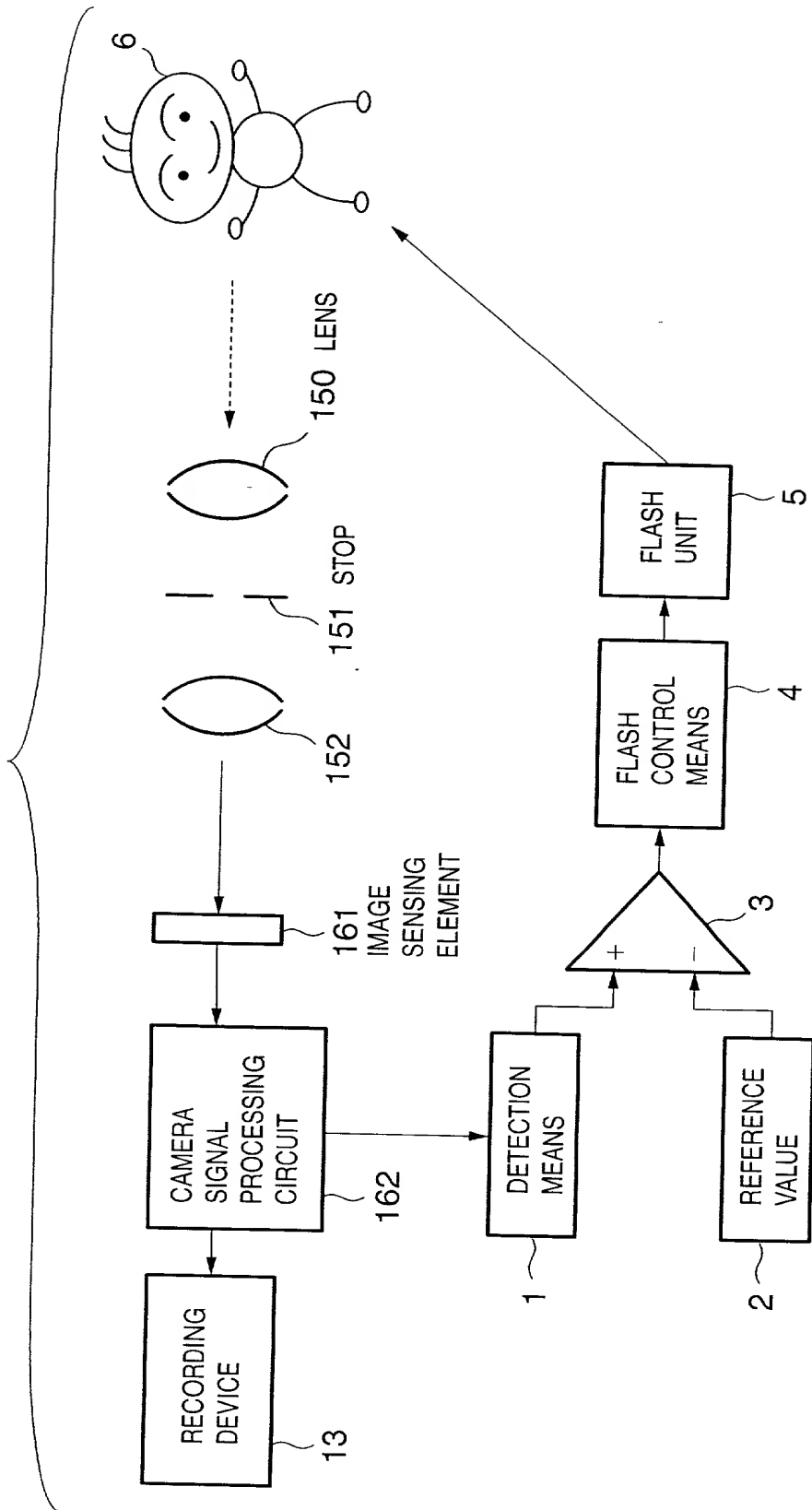
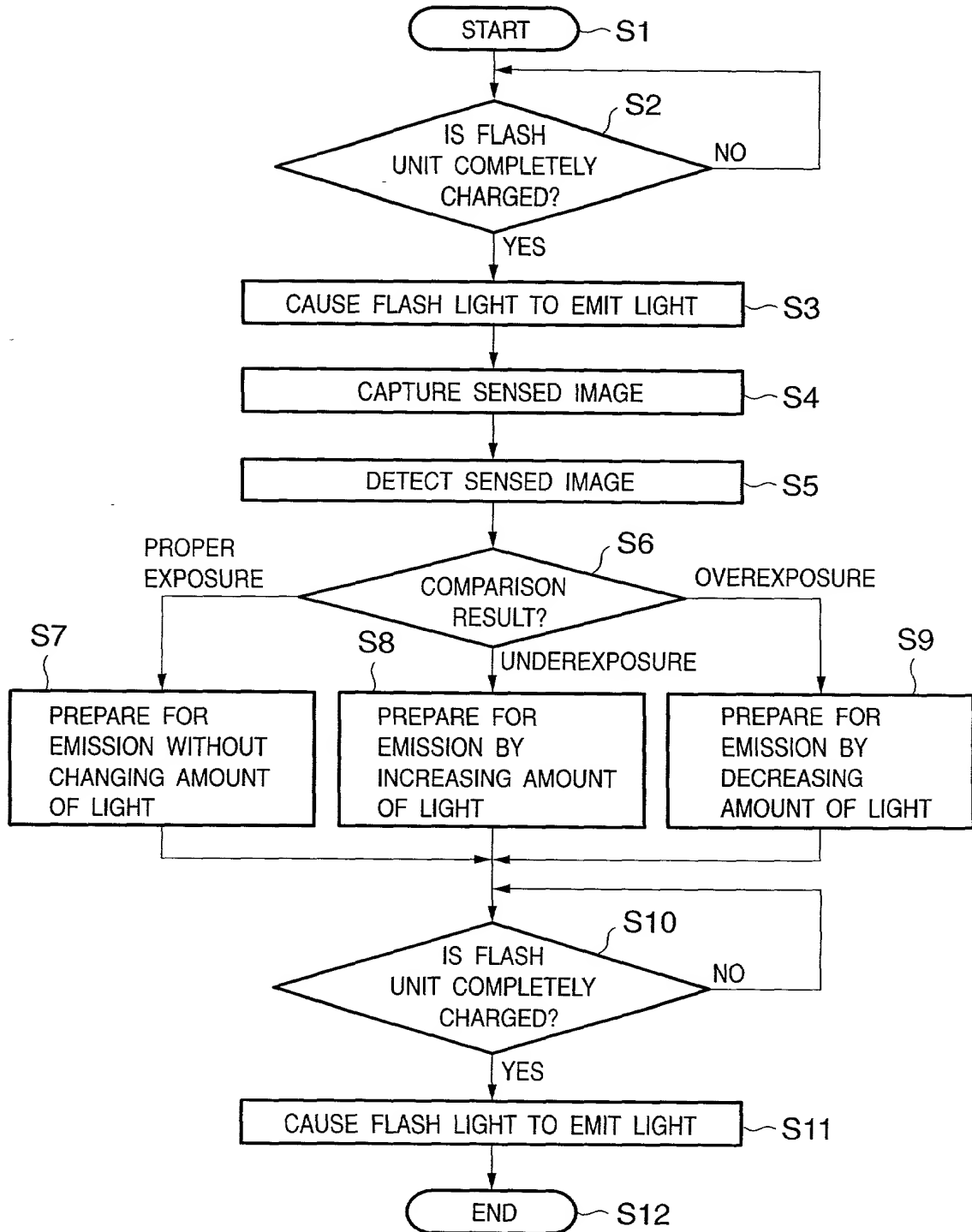

FIG. 3



FORGED 9164660

FIG. 4

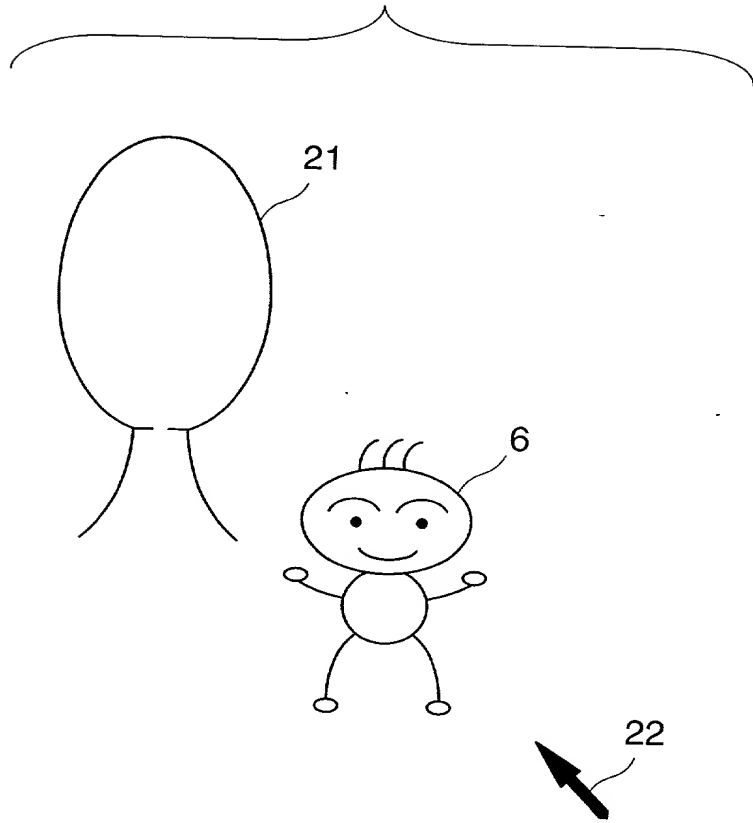

FIG. 4

FIG. 5

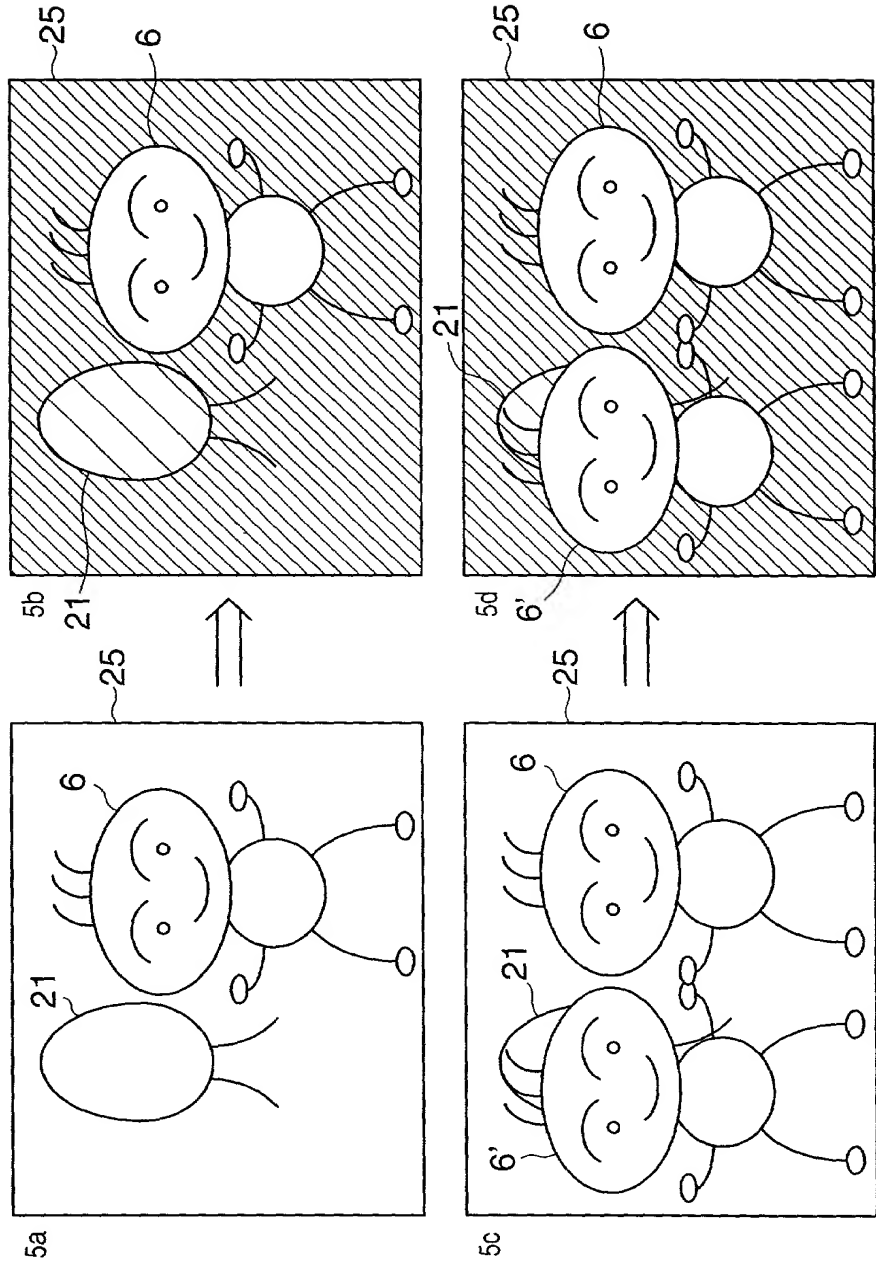
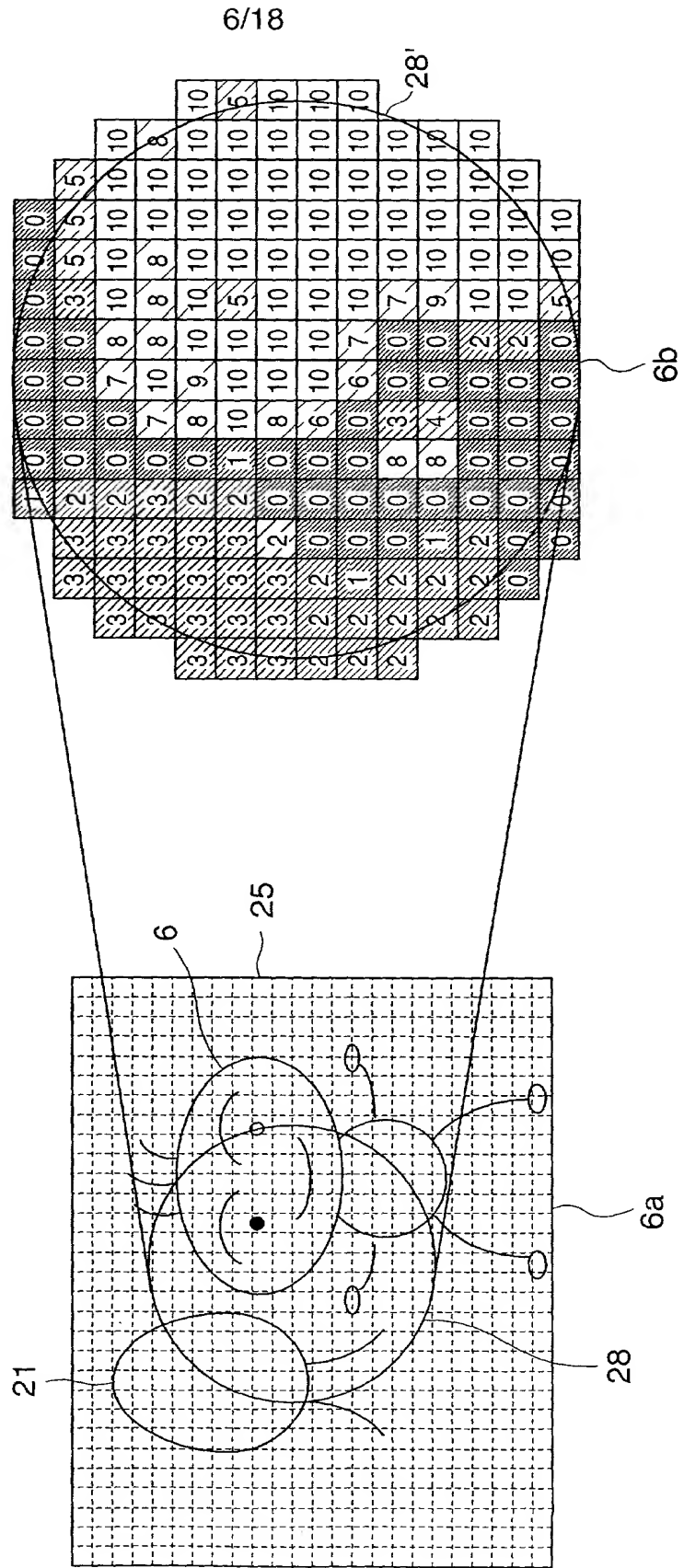
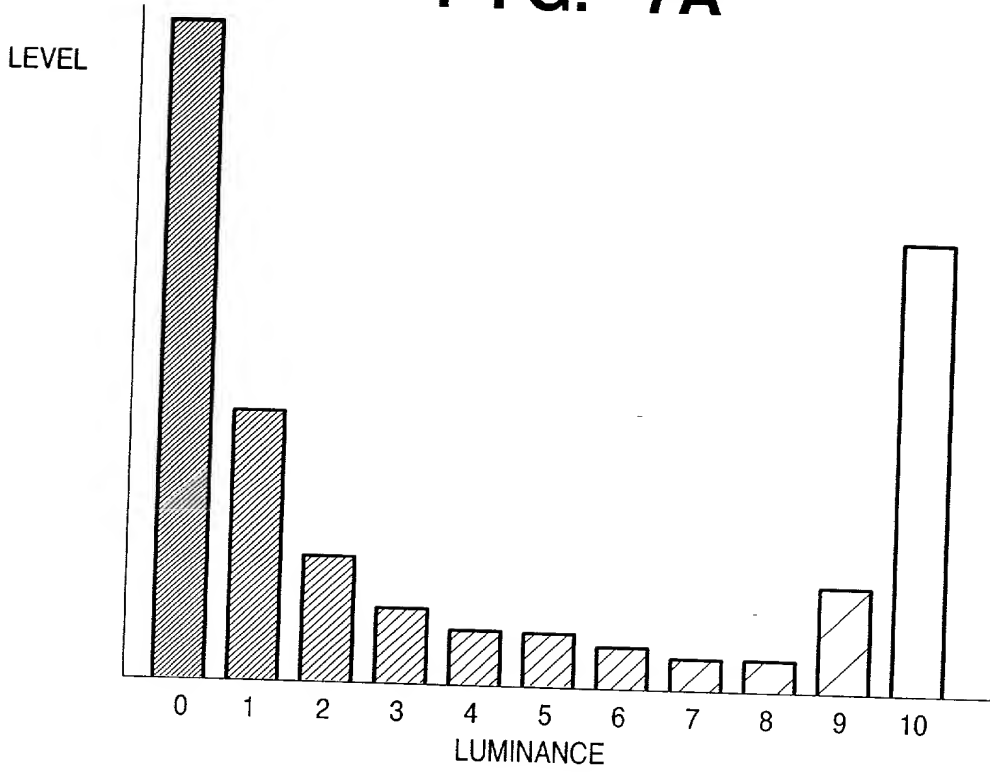

FIG. 6



**FIG. 7A**



**FIG. 7B**

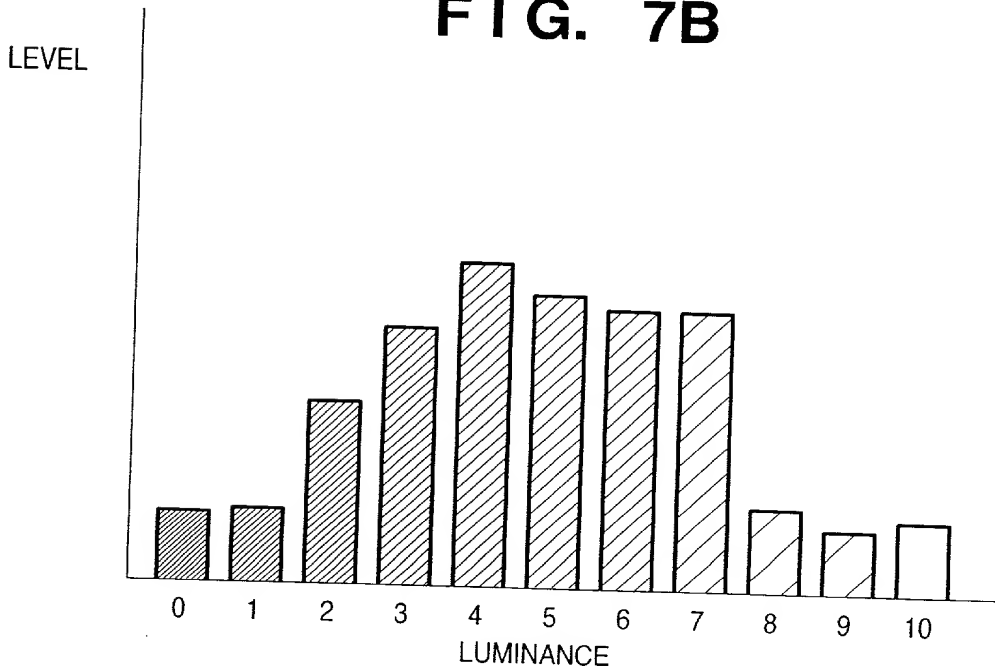

FIG. 8

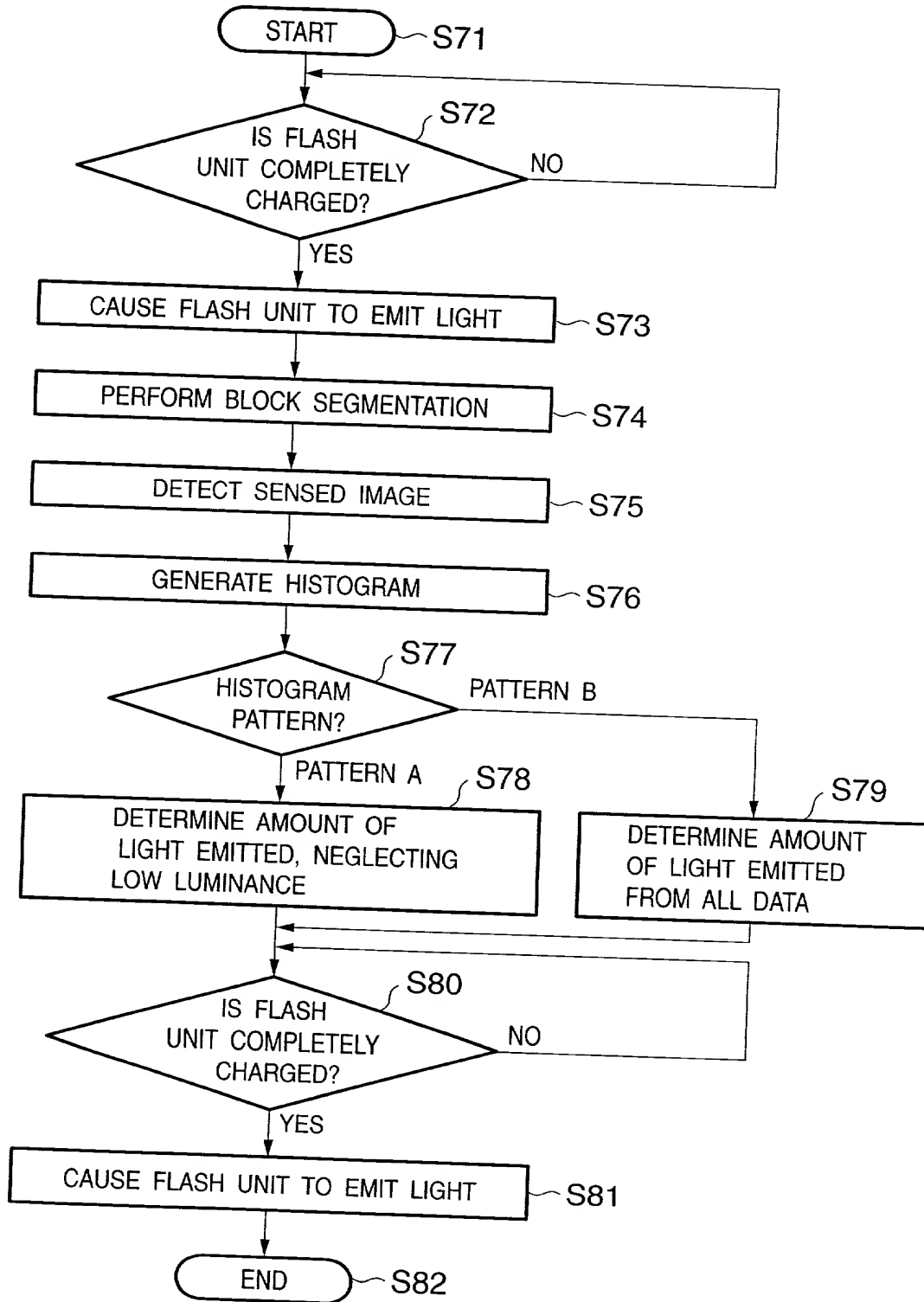

FIG. 8



FIG. 9

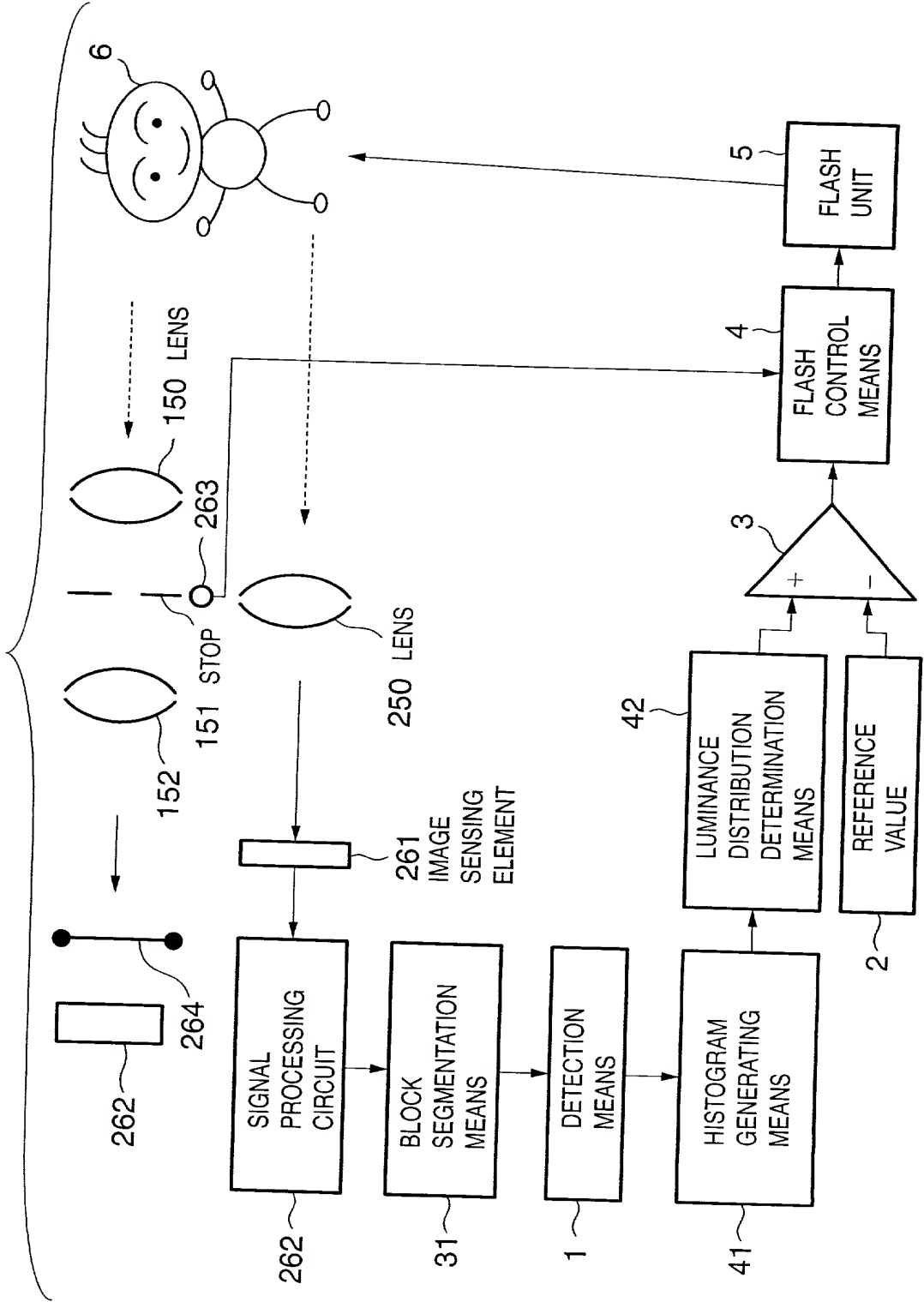

FIG. 10A

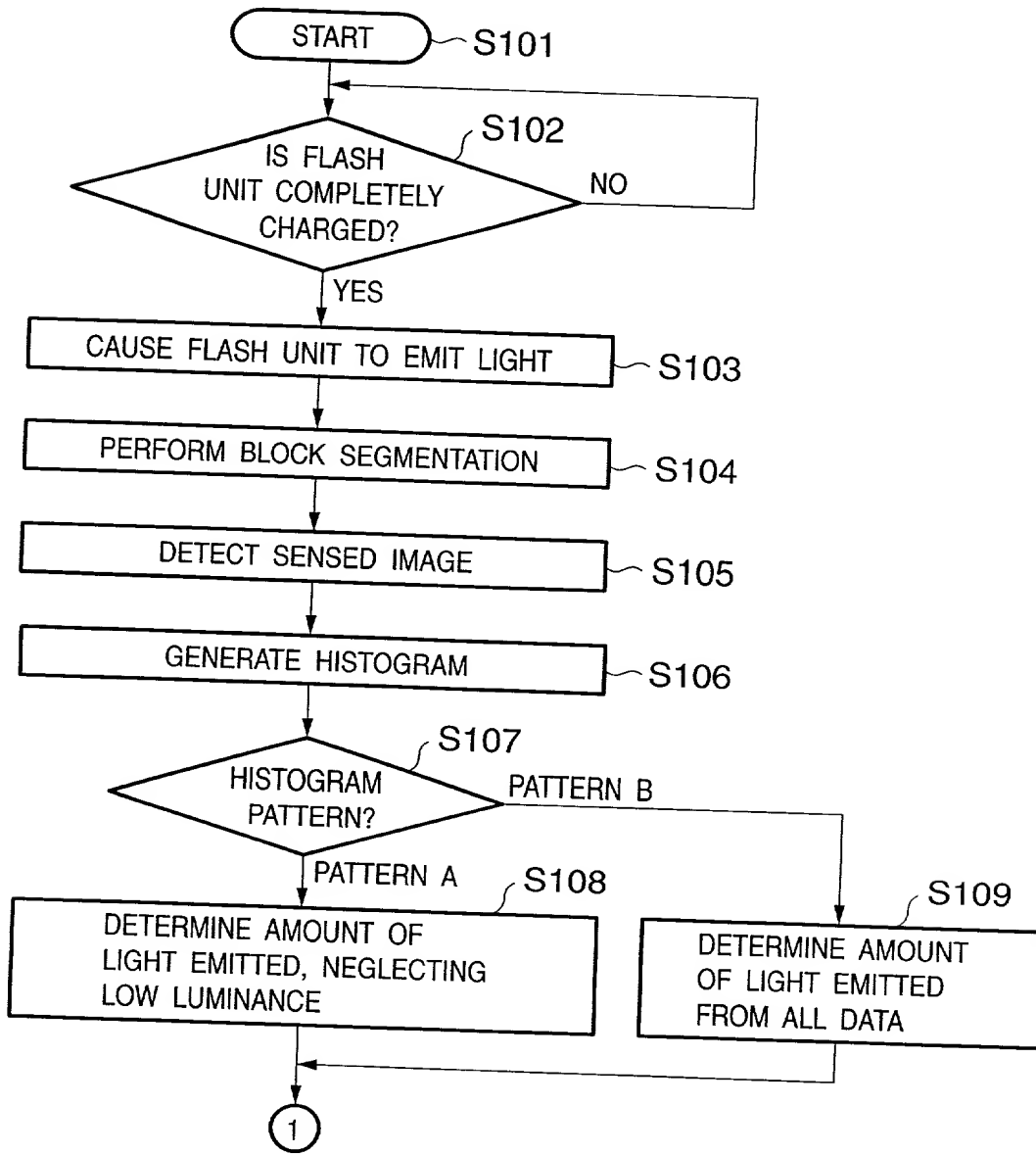
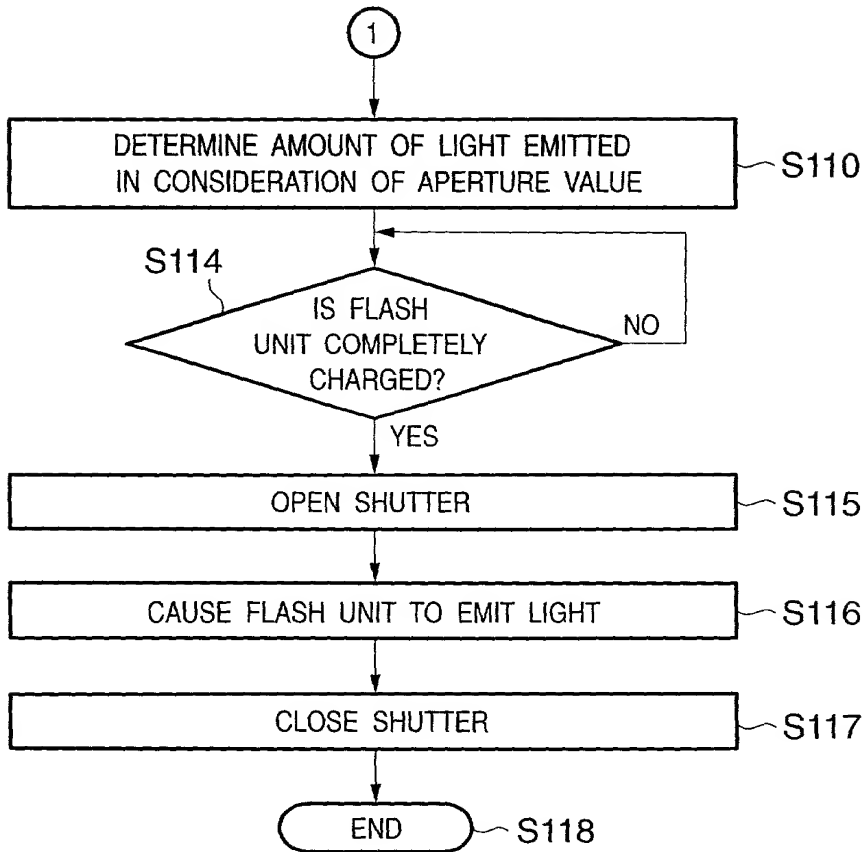

FIG. 10A

FIG. 10B



703000 3162650

FIG. 11

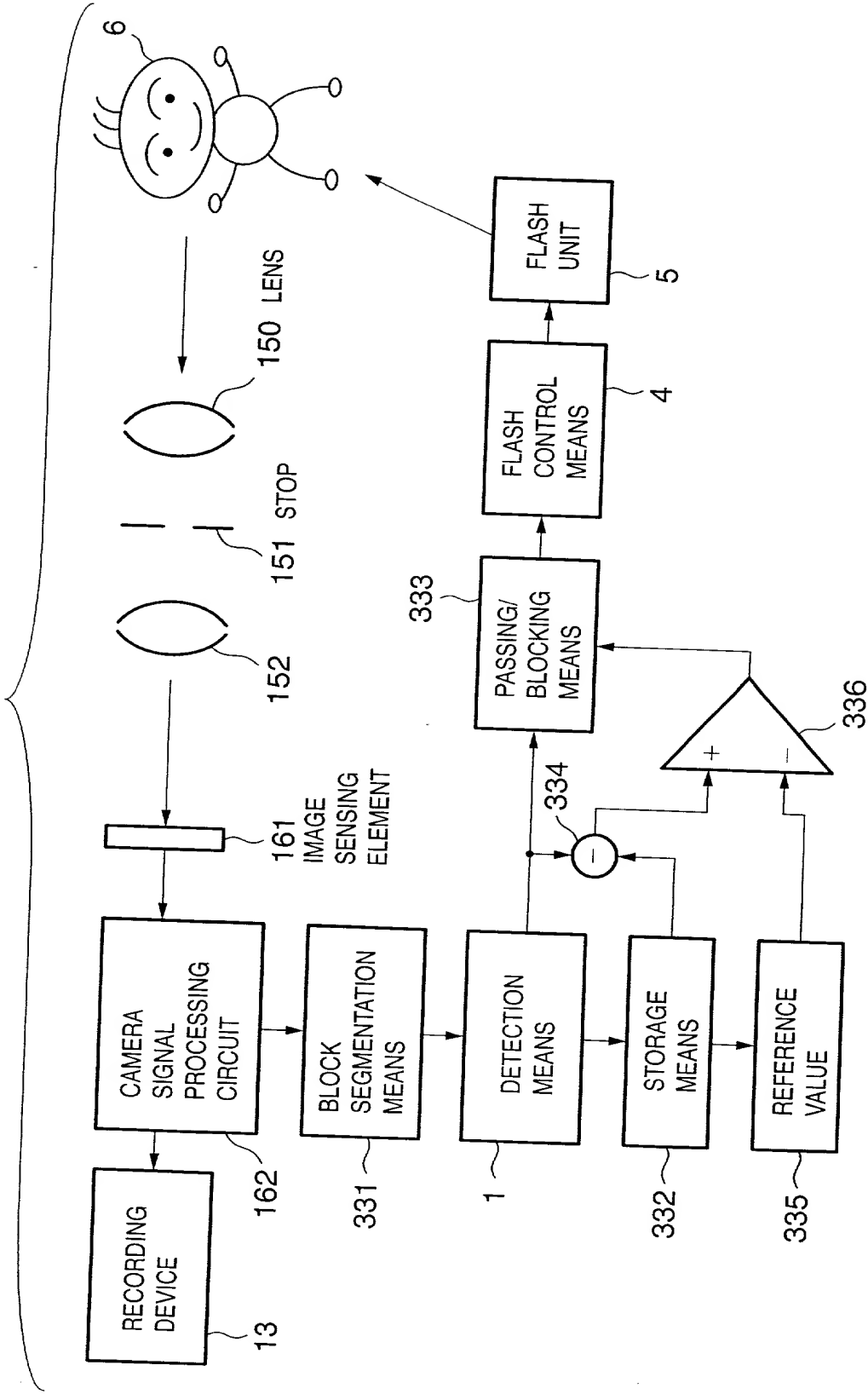

FIG. 12A

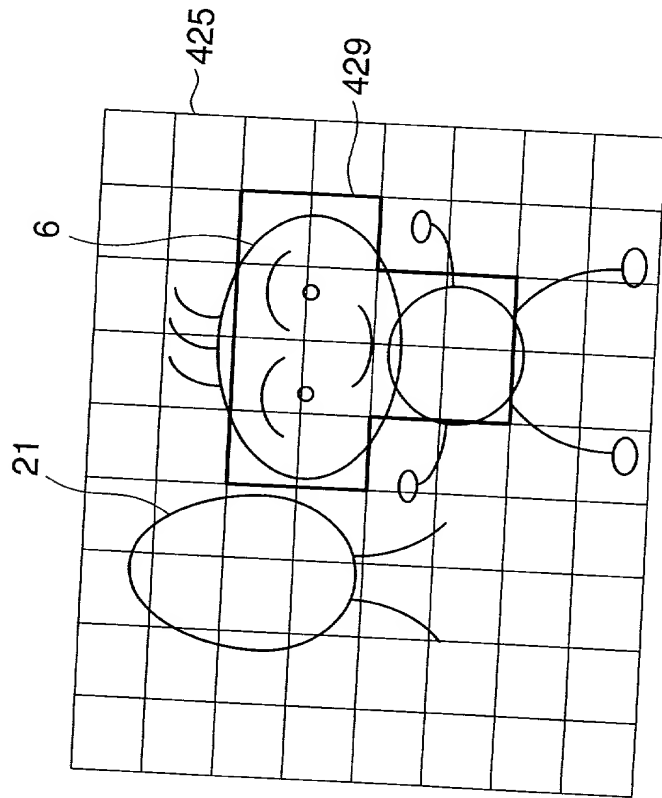

FIG. 12B

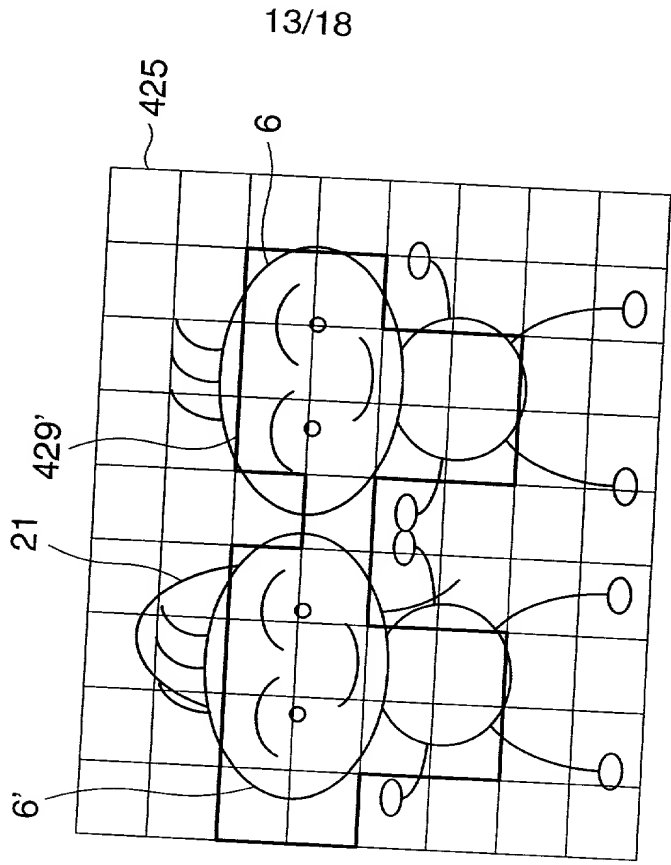

FIG. 13A

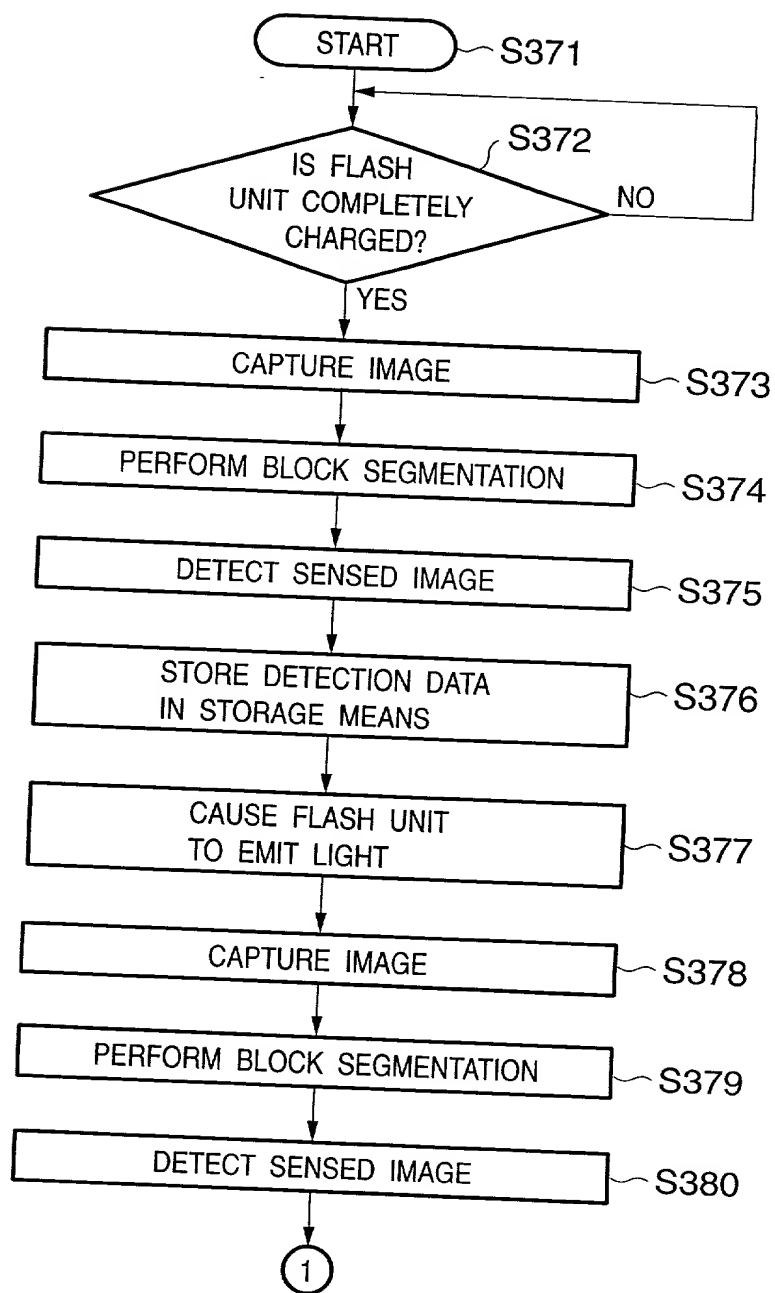

FIG. 13A

FIG. 13B

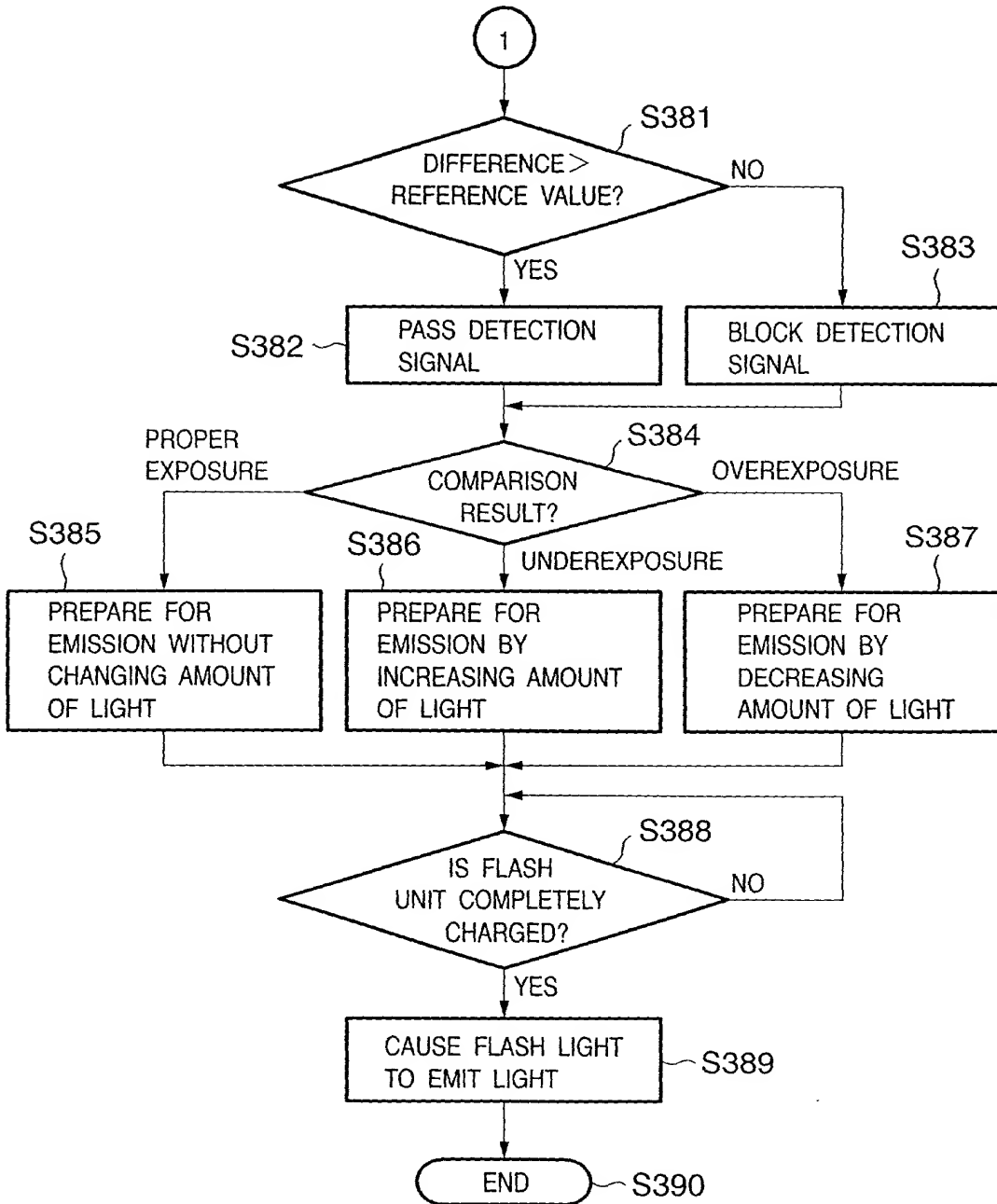

FIG. 13B

FIG. 14

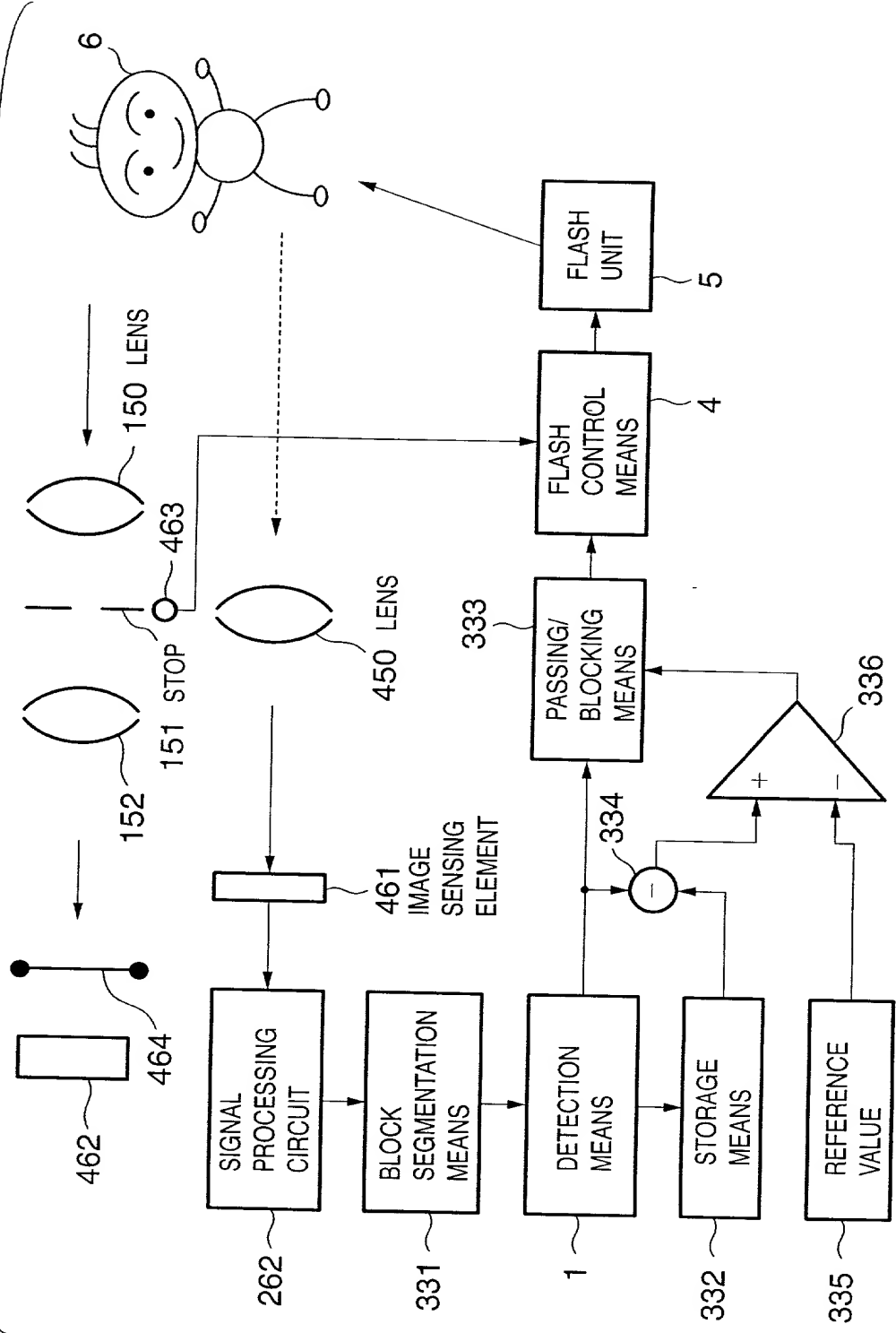
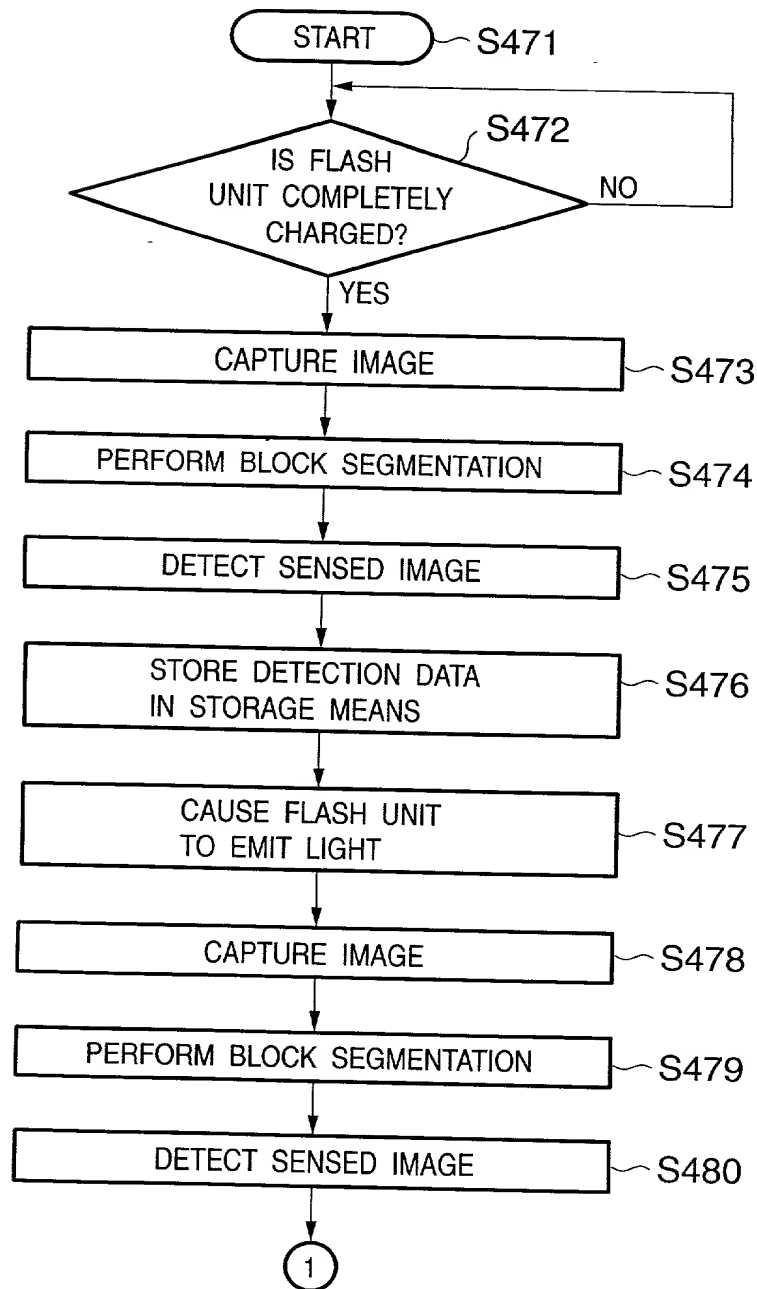

FIG. 14



FIG. 15A



# FIG. 15B

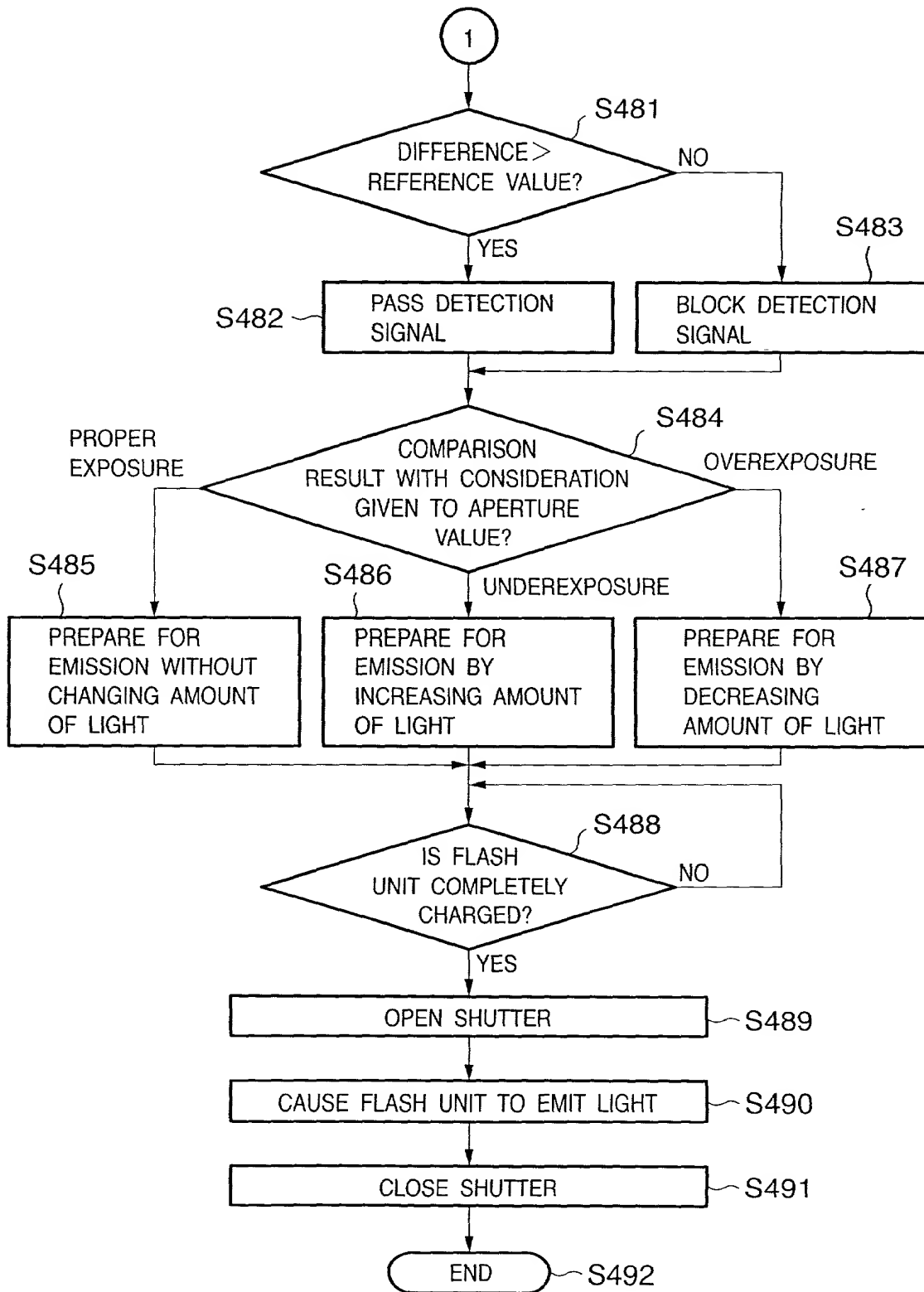

FOUO 946260